

STATISCHE ABMESSUNGEN

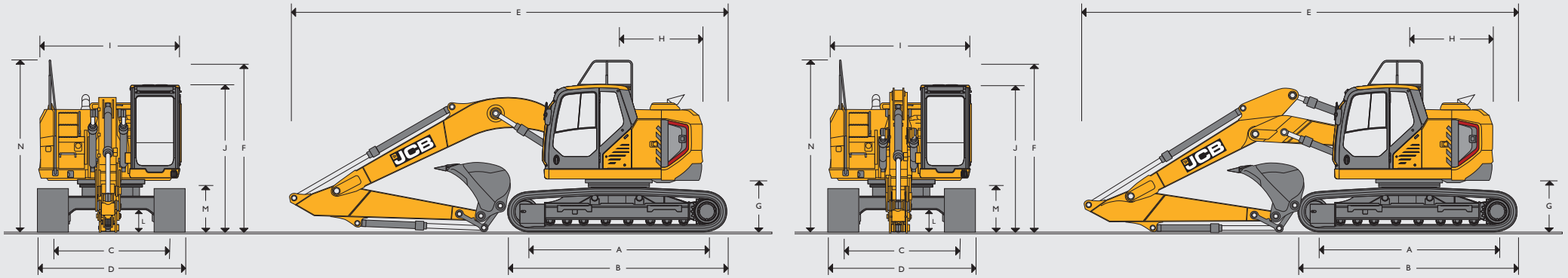

STATISCHE ABMESSUNGEN

Modell		245 XR	
A	Kettenaufstandslänge	mm	3.660
B	Laufwerksgesamtlänge	mm	4.469
C	Spurweite	mm	2.390
D	Laufwerksbreite (600-mm-Bodenplatten)	mm	2.990
D	Laufwerksbreite (700-mm-Bodenplatten)	mm	3.090
D	Laufwerksbreite (800-mm-Bodenplatten)	mm	3.190
D	Laufwerksbreite (900-mm-Bodenplatten)	mm	3.290
G	Bodenfreiheit Kontergewicht	mm	1.069
H	Hecklänge	mm	1.720
H	Heckschwenkradius	mm	1.720
I	Oberwagenbreite	mm	2.889
I	Oberwagenbreite (mit Kabinen-Haltegriff)	mm	2.912
J	Höhe über Kabine	mm	3.031
L	Bodenfreiheit	mm	486
M	Kettenhöhe	mm	899
N	Oberwagenhöhe mit Standard-Handlauf	mm	3.537
N	Gesamthöhe bis eingeklapptem Handlauf	mm	3.092
Monoblockausleger			
Löffelstiellänge		2,4 m	3,0 m
E	Transportlänge	mm	9.084
F	Transporthöhe mit Standard-Handlauf	mm	3.537
F	Transporthöhe mit einklappbarem Handlauf	mm	3.127
Verstellausleger			
Löffelstiellänge		2,4 m	3,0 m
E	Transportlänge	mm	9.107
F	Transporthöhe mit Standard-Handlauf	mm	3.537
F	Transporthöhe mit einklappbarem Handlauf	mm	3.152

MOTOR

Modell	JCB DieselMAX 448 Stufe V
Typ	4-Takt-/4-Zylinder-Reihenmotor, Direkteinspritzung, Diesel-Turbolader
Nennleistung	129 kW (173 PS)
Hubraum	4,8 Liter
Luftfilterung	Trockenelement mit Warnanzeige in der Kabine
Anlassersystem	24 Volt
Batterien	2 x 12 Volt
Lichtmaschine	28 Volt – 100 Ampere
Maximales Drehmoment	690 Nm bei 1.500 U/min
Bohrung und Hub	106 x 135 mm

SCHWENKSYSTEM

Schwenkmotor	Axialkolbentyp
Schwenkbremse	Hydraulische Bremse sowie automatisch wirkende Federspeicher-Scheibenfeststellbremse
Schwenkmoment	81,5 kNm
Schwenkgeschwindigkeit	10,4 U/min
Drehkranz	Großer Durchmesser, innenverzahnt, vollständig versiegelt, Schmierung mit Schmierfettbad.
Schwenksperre	Schaltbare Bremse in der Kabine

FAHRANTRIEB

Typ	Voll hydrostatisches Zweiganggetriebe mit Automatikschaltung
Fahrmotoren	Verstellbarer Axialkolbenmotor mit Schrägachse, geschützt im Laufwerksrahmen
Endantrieb	Planetenuntersetzung, angeschraubte Kettenräder
Betriebsbremse	Hydraulisch betätigte Bremse mit Ausgleichventil
Feststellbremse	Automatisch wirkende, hydraulisch lösende Federspeicher-Scheibenbremse
Steigfähigkeit	70 % (35°) kontinuierlich
Fahrgeschwindigkeit	Hoch – 5,7 km/h Niedrig – 3,2 km/h
Schubkraft (kN)	207,5 kNm

FÜLLMENGEN

Kraftstofftank	Liter	310
Motor Kühlmittel	Liter	27
Motoröl	Liter	20,4
Schwenkuntersetzungsgetriebe	Liter	11
Kettenuntersetzungsgetriebe (jede Seite)	Liter	3,5
Hydrauliksystem	Liter	250
Hydrauliktank	Liter	120
DEF-Flüssigkeitskapazität (sofern zutreffend)	Liter	31,4

HYDRAULIKSYSTEM
Pumpen

Hauptpumpen	2 Axialkolben-Verstellpumpen
Max. Förderleistung	2 x 228 l/min
Servopumpe	Zahnradpumpe
Max. Förderleistung Servopumpe	16 l/min

Steuerventil

Serienmäßig kombiniertes Steuerventil mit vier und fünf Kreisen und zusätzlichem Betriebsventil

Einstellungen des Druckbegrenzungsventils

Ausleger/Löffelstiel/Löffel	343 bar
Mit Powerboost (Kraftverstärkung)	373 bar
Schwenkkreis	280 bar
Fahrkreis	343 bar
Vorsteuerung	39 bar

Filtersystem

Tank	105 µm, Ansaugsieb
Hauptrücklaufleitung	10 µm, Glasfaserelement
Vorsteuerleitung	10 µm, Glasfaserelement
Rücklauf, hydraulischer Hammer	10 µm, verstärktes Mikrofaserelement

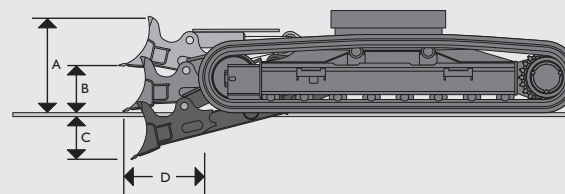
OPTIONALER SCHILD

A	Schildhöhe	mm	600
B	Schildhub über Boden	mm	500
C	Einstechtiefe Schild	mm	360
D	Abstand Schild zu Kette	mm	567
	Planierschildbreite (600 mm)	mm	2.990
	Planierschildbreite (700 mm)	mm	3.110

Zusätzliches Maschinengewicht mit Schild

600-mm-Ketten	kg	1.588
700-mm-Ketten	kg	1.602

GERÄUSCHPEGEL

Schalldruckpegel in der Fahrerkabine gemäß ISO 6396	69 dB LwA
Schalldruckpegel außen gemäß ISO 6395 und EU-Richtlinie 2000/14/EG	102 dB LwA

LAUFWERK				
Laufwerkoptionen	LC – Langes Laufwerk			
Bauweise	Vollständig geschweißter „X“-Rahmen, mittiger Unterbodenschutz und geneigte Längsträger mit Schmutzlöchern unter den oberen Rollen			
Schleppvorrichtung	Vorn und hinten			
Obere und untere Laufrollen	Wärmebehandelt versiegelt und geschmiert			
Ketteneinstellung	Fettzylindertyp			
Laufkettenrad	Versiegelt und geschmiert, mit gedämpftem Federrückstoß			
Kettentyp	Versiegelt und geschmiert			
Bodenplatten (mm)	600 mm	700 mm	800 mm	900 mm
	LC			
Anzahl obere Laufrollen	2			
Anzahl untere Laufrollen	8			
Anzahl Kettenführungen (Option)	2 oder vollständig			
Anzahl Bodenplatten	49			

LÖFFEL- UND LÖFFELSTIELKOMBINATIONEN 245XR

Löffeloptionen		GP-Löffel							HD-Löffel					
		610	762	915	1.067	1.219	1.372	1.524	750	900	1.100	1.200	1.350	1.500
Löffelbreite	mm	610	762	915	1.067	1.219	1.372	1.524	750	900	1.100	1.200	1.350	1.500
Löffelinhalt	m ³	0,35	0,51	0,66	0,81	0,96	1,11	1,27	0,52	0,66	0,81	0,96	1,11	1,25
Löffelgewicht	kg	479	531	589	644	715	772	842	610	691	752	813	894	955
245XR LC Mono														
2,4-m-Schnellwechsler (ohne Schnellwechsler)		☐ (☐)	☐ (☐)	☐ (☐)	☐ (☐)	☐ (☐)	☐ (☐)	☐ (☐)	☐ (☐)	☐ (☐)	☐ (☐)	☐ (☐)	☐ (☐)	☐ (☐)
3,0-m-Schnellwechsler (ohne Schnellwechsler)		☐ (☐)	☐ (☐)	☐ (☐)	☐ (☐)	☐ (☐)	☐ (☐)	■ (☐)	☐ (☐)	☐ (☐)	☐ (☐)	☐ (☐)	■ (☐)	■ (☐)
245XR LCD Mono														
2,4-m-Schnellwechsler (ohne Schnellwechsler)		☐ (☐)	☐ (☐)	☐ (☐)	☐ (☐)	☐ (☐)	☐ (☐)	☐ (☐)	☐ (☐)	☐ (☐)	☐ (☐)	☐ (☐)	☐ (☐)	☐ (☐)
3,0-m-Schnellwechsler (ohne Schnellwechsler)		☐ (☐)	☐ (☐)	☐ (☐)	☐ (☐)	☐ (☐)	☐ (☐)	■ (☐)	☐ (☐)	☐ (☐)	☐ (☐)	☐ (☐)	■ (☐)	■ (☐)
245XR LC Verstellausleger														
2,4-m-Schnellwechsler (ohne Schnellwechsler)		☐ (☐)	☐ (☐)	☐ (☐)	☐ (☐)	☐ (☐)	☐ (☐)	■ (☐)	☐ (☐)	☐ (☐)	☐ (☐)	☐ (☐)	☐ (☐)	■ (☐)
3,0-m-Schnellwechsler (ohne Schnellwechsler)		☐ (☐)	☐ (☐)	☐ (☐)	☐ (☐)	☐ (☐)	☐ (☐)	■ (☐)	☐ (☐)	☐ (☐)	☐ (☐)	☐ (☐)	■ (☐)	■ (■)
245XR LCD Verstellausleger														
2,4-m-Schnellwechsler (ohne Schnellwechsler)		☐ (☐)	☐ (☐)	☐ (☐)	☐ (☐)	☐ (☐)	☐ (☐)	☐ (☐)	☐ (☐)	☐ (☐)	☐ (☐)	☐ (☐)	☐ (☐)	☐ (☐)
3,0-m-Schnellwechsler (ohne Schnellwechsler)		☐ (☐)	☐ (☐)	☐ (☐)	☐ (☐)	☐ (☐)	☐ (☐)	■ (☐)	☐ (☐)	☐ (☐)	☐ (☐)	☐ (☐)	■ (☐)	■ (■)

- ☐ = Geeignet für allgemeine Aushubarbeiten mit einem Materialgewicht bis zu 2.000 kg/m³.
- = Geeignet für Grabenräum- und Beladearbeiten mit einem Materialgewicht bis zu 1.600 kg/m³.
- = Geeignet für leichte Aushubarbeiten mit einem Materialgewicht bis zu 1.200 kg/m³.
- X = Nicht empfohlen.

Diese Empfehlungen sind Richtwerte für normale Betriebsbedingungen.
Wenden Sie sich bezüglich der Auswahl passender Löffel und Anbaugeräte für den jeweiligen Einsatz an Ihren Händler.

TECHNISCHE DATEN 245XR

GEWICHTE UND BODENDRÜCKE

Die Zahlen basieren auf: 1,1-m³-Löffel 772 kg, Bediener 75 kg, voller Kraftstofftank und 2,4 m Löffelstlänge

	Bodenplattenoptionen				
	600 mm STD	700 mm STD	800 mm STD	900 mm STD	
245XR LC Monoausleger					
Maschinengewicht	kg	25.023	25.292	25.579	25.848
Bodendruck	kg/cm ²	0,50	0,43	0,38	0,34
245XR LC Monoausleger und Schild					
Maschinengewicht	kg	26.632	26.915	-	-
Bodendruck	kg/cm ²	0,53	0,46	-	-
		600 mm HD	700 mm HD	800 mm HD	900 mm HD
245XR LC Monoausleger					
Maschinengewicht	kg	25.284	25.603	25.941	26.261
Bodendruck	kg/cm ²	0,50	0,44	0,39	0,35
245XR LC Monoausleger und Schild					
Maschinengewicht	kg	26.893	27.226	-	-
Bodendruck	kg/cm ²	0,54	0,47	-	-
Die Zahlen basieren auf: 1,1-m ³ -Löffel 772 kg, Bediener 75 kg, voller Kraftstofftank und 3,0 m Löffelstlänge					
		600 mm STD	700 mm STD	800 mm STD	900 mm STD
245XR LC Monoausleger					
Maschinengewicht	kg	25.095	25.365	25.652	25.920
Bodendruck	kg/cm ²	0,50	0,43	0,38	0,34
245XR LC Monoausleger und Schild					
Maschinengewicht	kg	26.704	26.987	-	-
Bodendruck	kg/cm ²	0,53	0,46	-	-
		600 mm HD	700 mm HD	800 mm HD	900 mm HD
245XR LC Monoausleger					
Maschinengewicht	kg	25.356	25.676	26.014	26.333
Bodendruck	kg/cm ²	0,51	0,44	0,39	0,35
245XR LC Monoausleger und Schild					
Maschinengewicht	kg	26.965	27.299	-	-
Bodendruck	kg/cm ²	0,54	0,47	-	-

GEWICHTE UND BODENDRÜCKE

Die Zahlen basieren auf: 1,1-m³-Löffel 772 kg, Bediener 75 kg, voller Kraftstofftank und 2,4 m Löffelstlänge

	Bodenplattenoptionen				
	600 mm STD	700 mm STD	800 mm STD	900 mm STD	
245XR LC Verstellausleger					
Maschinengewicht	kg	25.733	26.003	26.290	26.558
Bodendruck	kg/cm ²	0,51	0,44	0,39	0,35
245XR LC Verstellausleger Planierschild					
Maschinengewicht	kg	27.342	27.626	-	-
Bodendruck	kg/cm ²	0,55	0,47	-	-
		600 mm HD	700 mm HD	800 mm HD	900 mm HD
245XR LC Verstellausleger					
Maschinengewicht	kg	25.994	26.314	26.652	26.971
Bodendruck	kg/cm ²	0,52	0,45	0,40	0,36
245XR LC Verstellausleger Planierschild					
Maschinengewicht	kg	27.603	27.937	-	-
Bodendruck	kg/cm ²	0,55	0,48	-	-
Die Zahlen basieren auf: 1,1-m ³ -Löffel 772 kg, Bediener 75 kg, voller Kraftstofftank und 3,0 m Löffelstlänge					
		600 mm STD	700 mm STD	800 mm STD	900 mm STD
245XR LC Verstellausleger					
Maschinengewicht	kg	25.806	26.075	26.362	26.631
Bodendruck	kg/cm ²	0,51	0,45	0,39	0,35
245XR LC Verstellausleger Planierschild					
Maschinengewicht	kg	27.414	27.698	-	-
Bodendruck	kg/cm ²	0,55	0,47	-	-
		600 mm HD	700 mm HD	800 mm HD	900 mm HD
245XR LC Verstellausleger					
Maschinengewicht	kg	26.067	26.386	26.724	27.044
Bodendruck	kg/cm ²	0,52	0,45	0,40	0,36
245XR LC Verstellausleger Planierschild					
Maschinengewicht	kg	27.675	28.009	-	-
Bodendruck	kg/cm ²	0,55	0,48	-	-

ARBEITSBEREICH **245XR LC MONO**

Löffelstiellänge:		2,4 m	3,0 m	
A	Max. Grabreichweite	mm	9.423	9.952
B	Max. Grabreichweite (am Boden)	mm	9.244	9.784
C	Max. Grabtiefe	mm	6.029	6.627
D	Max. Schürfhöhe	mm	10.354	10.708
E	Max. Schütthöhe	mm	7.593	7.951
F	Max. vertikale Grabtiefe	mm	5.459	6.011
G	Mindestschwenkradius	mm	2.566	2.345
	Löffelrotation	Grad	183	183
	Max. Ausbrechkraft Löffelstiel	kN	125	103
	Maximale Löffel-Ausbrechkraft	kN	148	148
Löffel für Berechnung		980/B0090		

ARBEITSBEREICH **245XR LC VERSTELLAUSLEGER**

Löffelstiellänge:		2,4 m	3,0 m	
A	Max. Grabreichweite	mm	9.472	10.009
B	Max. Grabreichweite (am Boden)	mm	9.295	9.841
C	Max. Grabtiefe	mm	5.619	6.200
D	Max. Schürfhöhe	mm	10.615	11.013
E	Max. Schütthöhe	mm	7.827	8.228
F	Max. vertikale Grabtiefe	mm	4.749	5.326
G	Mindestschwenkradius	mm	2.500	2.206
	Löffelrotation	Grad	183	183
	Max. Ausbrechkraft Löffelstiel	kN	125	103
	Maximale Löffel-Ausbrechkraft	kN	148	148
Löffel für Berechnung		980/B0090		

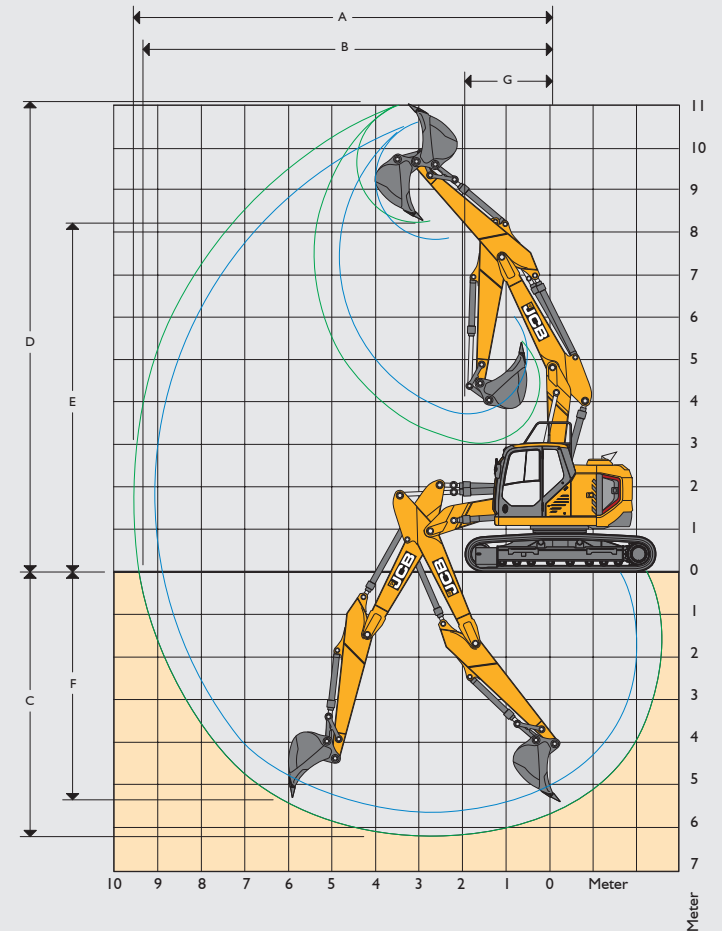
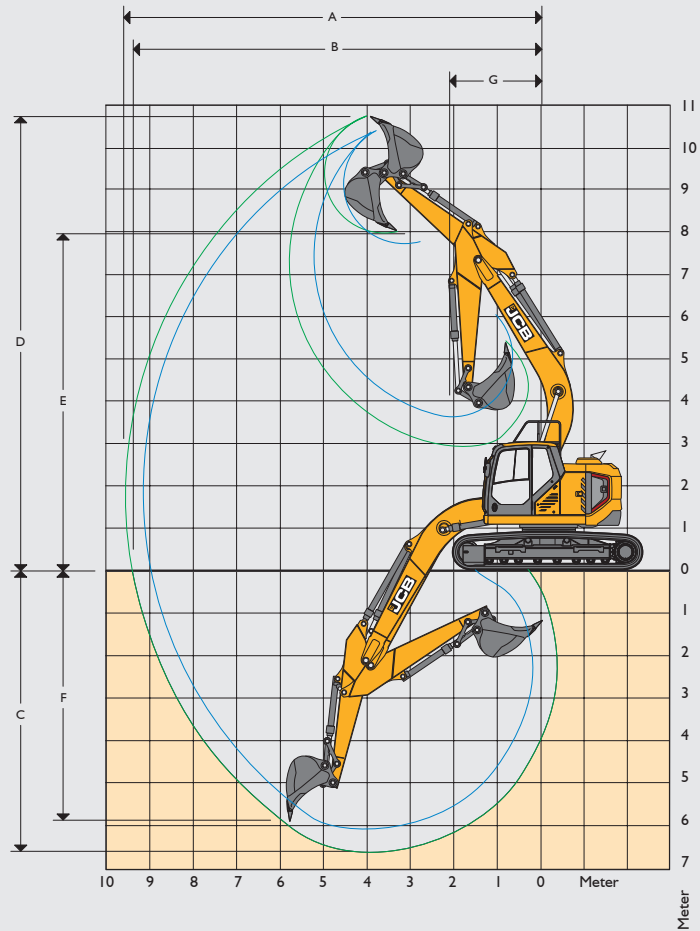

STANDARD AUSSTATTUNG/OPTIONALE ZUSATZAUSSTATTUNG

MOTOR

Stufe-V-konformer, elektronischer 4,8-Liter-JCB-Motor; 4 Zylinder, SCR, Wassergekühlter Diesel-Turbolader, nachgekühlt	•
Leerlauf auf Knopfdruck	•
Automatische Leerlaufschaltung	•
Automatische Motorabschaltung	•
Lüfterschutz	•
Schwerlastbatterien	•
Kraftstofffilter: mit Sedimentabscheider	•
Elektronische Motorsteuerung	•
Kraftstoffkühler	•
Betankungspumpe mit integriertem Filter	+
Kraftstofffilter für Betankungspumpe	•

SICHERHEIT

Seitliche Absturzsicherung an Oberwagen und Trittstufen	•
Doppelkamera	•
Batterie Hauptschalter	•
Schlüssel	•
Abschließbarer Kraftstofftankdeckel	•
Abschließbarer Hydrauliktankdeckel	•
Arbeitsscheinwerfer (2 am Drehrahmen, 2 am Ausleger)	•
Überrollschutz (ROPS)	•
Fahralarm	•
Zusätzliche Scheinwerferoptionen (Ebenen 2 und 3 erhältlich als Halogen- oder LED-Ausführung)	+
Rückfahralarm	+
Grüne Rundumleuchte mit Sicherheitsgurtanbindung	+
FOPS-Level-II-Schutzvorrichtung – Ober- und Vorderseite	+
Feuerlöscher (1 kg Löschpulver)	+
Vandalismusschutzvorrichtungen	+
Signalstreifen am Kontergewicht	+
Dachmontierte Rundumleuchte	+
2 Rundumleuchten am Kontergewicht	+
360°-Kamera	+
Umladbare Handläufe	+
Umlaufende Handläufe oben	+
Stielbegrenzung	+

KABINE UND INNENAUSSTATTUNG

Schallgedämmte und 4-fach doppelt schwingungs isolierte Kabine	•
Mechanischer gefederter Sitz	•
Heizung	•
Öffnende Frontscheibe und entnehmbare untere Frontscheibe	•
Oberes Türfenster in 2 Richtungen verschiebbar	•
Frontscheibenwischer oben	•
4-Tasten-Joysticks	•
Fahrpedale und Hebel mit T-Griff	•
2 Fußstützen	•
Wegfahrsperre	•
Lautsprecher und Anschluss für Radio	•
Standard-Kabinenluftfilterung	•
Elektrische 2-Ton-Hupe	•
Kabineninnenbeleuchtung	•
3 x 12-V-Buchsen	•
7"-Farbmonitor	•
Einziehbarer 2"-Sicherheitsgurt	•
Fest eingebautes Dachfenster	•
Sonnenblende für Dach	•
Kühlbox	•
Becherhalter	•
Klimaanlage	•
Sonnenblende für Heckfenster	+
3"-Sicherheitsgurt	+
2"-Hi-Viz-Sicherheitsgurt	+
3"-Hi-Viz-Sicherheitsgurt	+
Sonnenblende für Front	+
Sonnenblende für Seitenfenster	+
Ausstellbare Dachluke	+
Bluetooth-Radio (verbunden mit Konsolen-Bedienelementen und Monitor)	+
Aktivkohle-Luftfilter	+
Deluxe-Sitz: Beheizter, einstellbarer Sitz mit Luftfederung sowie mit verstellbarer Kopfstütze und mechanischer Lendenwirbelstütze	+
Super-Deluxe-Sitz: beheizbarer, belüfteter und verstellbarer Sitz mit Luftfederung, verstellbarer Kopfstütze und elektrischer Lendenstütze	+
Regenvisier	+
Doppelscheibenwischer vorn	+

LAUFWERK

Dauergeschmierte und gekapselte Kettenglieder	•
Doppelter Kettenschutz	•
Durchgehender Kettenschutz	+
Dreisteg-Bodenplatte 500, 600, 700, 800, 900 mm	+
Schild für LC-Fahrwerk mit 600-mm- oder 700-mm-Ketten	+

HYDRAULIKSYSTEM

Ausleger- und Arm-Durchflussregeneration	•
Powerboost auf Tastendruck	•
Ausleger-/Schwenkprioritätssteuerung	•
Dämpfungssteuerung	•
Zylinderdämpfung und Kontaminationsschutz	•
2-Gang-Fahrmotoren	•
Ölkühler	•
10 Anbaugeräteinstellungen über Display	•
Hi-Flow-, Medium-Flow-, Low-Flow-Optionen und Summenschaltung (Absperrramaturen serienmäßig)	+
Advanced Tool Select mit Durchfluss- und Drucksteuerung	+
Proportionalregler am Joystick mit elektronischem Fußpedal	+
Bio-Öl	+
Panolin-Öl	+
Verrohrung für Schnellwechsler	+
Hydraulischer Schnellwechsler	+
ISO/SAE-Umschaltung	+
SAE-auf-BSP-Adapter für Hi-Flow-Zusatzverrohrung	+
Schnellkupplungen	+
Schlauchbruchventile (Ausleger, Arm und Löffel)	+
Zusatzentlüftung für Tank	+
Ablauf für Anbaugeräte-Kasten	+
Vorbereitung für Steelwrist	+

GRABAUSRÜSTUNG













Schmiernippelbank	•
Löffelstielängen – 2,4 m, 3,0 m	+
HD-Löffelstiele 2,4 m, 3,0 m	+
Kippelement für Hubhaken	+
Kippelement für Huböse	+
Löffelzylinderschutz	+
Verstellausleger	+
Schutzgitter für auslegermontierte Scheinwerfer	+

ANDERES













Stundenzähler	•
Kühler mit breitem Kühlerblock	•
LiveLink-Telematik	•
HD-Drehkranzlagerdichtung	•
10-mm-Schwerlastplatten für Ober- und Unterwagen	+
Gefaltetes Heizkörper-Fliegengitter	+
Arbeitsscheinwerferschutzgitter	+
Beleuchtung für Servicebereich und Zugang	+
GPS-Vorbereitung	+

STANDARD •
OPTIONAL +













NENNTRAGFÄHIGKEIT – LÖFFELSTIELLÄNGE 2,4 M, MONOAUSLEGER, BODENPLATTEN: 600HD, KEIN LÖFFEL **245XR LC MONO**

Reichweite	1,5 m		3 m		4,5 m		6 m		7,5 m		Hubkapazität bei max. Reichweite		
													
Lastpunkthöhe	kg	kg	kg	kg	kg	kg	kg	kg	kg	kg	kg	kg	mm
7,5 m					6.828*	6.828*					5.081*	5.081*	5.585
6 m					7.081*	7.081*	6.390*	5.277			4.640*	4.240	6.811
4,5 m			11.686*	11.686*	8.237*	7.968	6.791*	5.102	4.890*	3.556	4.530*	3.518	7.546
3 m					9.833*	7.324	7.448*	4.834	5.626	3.465	4.628*	3.170	7.929
1,5 m					10.950*	6.809	7.668	4.582	5.500	3.350	4.927*	3.044	8.013
0 m					11.041*	6.584	7.486	4.421	5.417	3.274	5.122	3.106	7.808
-1,5 m			10.237*	10.237*	10.269*	6.558	7.433	4.376			5.642	3.404	7.289
-3 m			10.987*	10.987*	8.598*	6.676	6.322*	4.468			5.634*	4.147	6.376
-4,5 m					5.121*	5.121*					4.477*	4.477*	4.850

NENNTRAGFÄHIGKEIT – LÖFFELSTIELLÄNGE 3,0 M, MONOAUSLEGER, BODENPLATTEN: 600HD, KEIN LÖFFEL **245XR LC MONO**

Reichweite	1,5 m		3 m		4,5 m		6 m		7,5 m		Hubkapazität bei max. Reichweite		
													
Lastpunkthöhe	kg	kg	kg	kg	kg	kg	kg	kg	kg	kg	kg	kg	mm
7,5 m							4.288*	4.288*			3.298*	3.298*	6.327
6 m					5.780*	5.780*	5.633*	5.392			3.062*	3.062*	7.429
4,5 m			8.436*	8.436*	7.452*	7.452*	6.308*	5.198	5.109*	3.622	3.007*	3.007*	8.107
3 m			10.220*	10.220*	9.126*	7.537	7.050*	4.912	5.666	3.497	3.075*	2.872	8.464
1,5 m					10.544*	6.938	7.725	4.626	5.512	3.356	3.268*	2.758	8.543
0 m			5.879*	5.879*	11.059*	6.602	7.492	4.420	5.393	3.248	3.624*	2.798	8.351
-1,5 m	6.190*	6.190*	9.928*	9.928*	10.659*	6.497	7.387	4.328	5.350	3.208	4.266*	3.019	7.868
-3 m	10.456*	10.456*	12.710*	12.710*	9.390*	6.556	7.012*	4.357			5.482*	3.551	7.034
-4,5 m			9.004*	9.004*	6.835*	6.786					4.926*	4.900	5.691

NENNTRAGFÄHIGKEIT – LÖFFELSTIELLÄNGE 2,4 M, MONOAUSLEGER, BODENPLATTEN: 600HD, KEIN LÖFFEL **245XR LCD MONO**

Reichweite	1,5 m		3 m		4,5 m		6 m		7,5 m		Hubkapazität bei max. Reichweite		
													
Lastpunkthöhe	kg	kg	kg	kg	kg	kg	kg	kg	kg	kg	kg	kg	mm
7,5 m					6.828*	6.828*					5.081*	5.081*	5.585
6 m					7.081*	7.081*	6.390*	5.605			4.640*	4.520	6.811
4,5 m			11.686*	11.686*	8.237*	8.237*	6.791*	5.429	4.890*	3.806	4.530*	3.765	7.546
3 m					9.833*	7.804	7.448*	5.162	5.729	3.713	4.628*	3.403	7.929
1,5 m					10.950*	7.290	7.809	4.910	5.604	3.599	4.927*	3.274	8.013
0 m					11.041*	7.065	7.627	4.749	5.521	3.524	5.221	3.343	7.808
-1,5 m			10.237*	10.237*	10.269*	7.039	7.574	4.703			5.750	3.662	7.289
-3 m			10.987*	10.987*	8.598*	7.157	6.322*	4.796			5.634*	4.450	6.376
-4,5 m					5.121*	5.121*					4.477*	4.477*	4.850





Hubkapazität in Längsrichtung













Hubkapazität im gesamten Schwenkbereich

Hinweise:

1. Die Hubkapazitäten basieren auf ISO 10567, d. h.: 75 % der Kippplast oder 87 % der Hydraulikhubkapazität – es gilt der jeweils kleinere Wert. Mit * markierte Hubkapazitäten basieren auf der Hydraulikhubkapazität.
2. Die angegebenen Hubkapazitäten setzen festen, ebenen Grund voraus.
3. Unterschiedliche Länder haben ggf. andere gesetzliche Bestimmungen. Fragen Sie bitte Ihren Händler.

NENNTRAGFÄHIGKEIT – LÖFFELSTIELLÄNGE 3,0 M, MONOAUSLEGER, BODENPLATTEN: 600HD, KEIN LÖFFEL													245XR LCD MONO
Reichweite	1,5 m		3 m		4,5 m		6 m		7,5 m		Hubkapazität bei max. Reichweite		
													
Lastpunkthöhe	kg	kg	kg	kg	kg	kg	kg	kg	kg	kg	kg	kg	mm
7,5 m							4.288*	4.288*				3.298*	6.327
6 m					5.780*	5.780*	5.633*	5.633*				3.062*	7.429
4,5 m			8.436*	8.436*	7.452*	7.452*	6.308*	5.526	5.109*	3.872		3.007*	8.107
3 m			10.220*	10.220*	9.126*	8.018	7.050*	5.240	5.770	3.746		3.075*	8.464
1,5 m					10.544*	7.418	7.747*	4.954	5.616	3.605		3.268*	8.543
0 m			5.879*	5.879*	11.059*	7.082	7.634	4.748	5.497	3.496		3.624*	8.351
-1,5 m	6.190*	6.190*	9.928*	9.928*	10.659*	6.978	7.528	4.656	5.453	3.457		4.266*	7.868
-3 m	10.456*	10.456*	12.710*	12.710*	9.390*	7.036	7.012*	4.684				5.482*	7.034
-4,5 m			9.004*	9.004*	6.835*	6.835*						4.926*	5.691

NENNTRAGFÄHIGKEIT – LÖFFELSTIELLÄNGE 2,4 M, MONOAUSLEGER, BODENPLATTEN: 700HD, KEIN LÖFFEL													245XR LC MONO
Reichweite	1,5 m		3 m		4,5 m		6 m		7,5 m		Hubkapazität bei max. Reichweite		
													
Lastpunkthöhe	kg	kg	kg	kg	kg	kg	kg	kg	kg	kg	kg	kg	mm
7,5 m					6.828*	6.828*						5.081*	5.585
6 m					7.081*	7.081*	6.390*	5.342				4.640*	6.811
4,5 m			11.686*	11.686*	8.237*	8.063	6.791*	5.167	4.890*	3.606		4.530*	7.546
3 m					9.833*	7.419	7.448*	4.900	5.705	3.514		4.628*	7.929
1,5 m					10.950*	6.905	7.776	4.648	5.580	3.400		4.927*	8.013
0 m					11.041*	6.680	7.594	4.486	5.497	3.324		5.198	7.808
-1,5 m			10.237*	10.237*	10.269*	6.653	7.542	4.440				5.725	7.289
-3 m			10.987*	10.987*	8.598*	6.772	6.322*	4.533				5.634*	6.376
-4,5 m					5.121*	5.121*						4.477*	4.850

NENNTRAGFÄHIGKEIT – LÖFFELSTIELLÄNGE 3,0 M, MONOAUSLEGER, BODENPLATTEN: 700HD, KEIN LÖFFEL													245XR LC MONO
Reichweite	1,5 m		3 m		4,5 m		6 m		7,5 m		Hubkapazität bei max. Reichweite		
													
Lastpunkthöhe	kg	kg	kg	kg	kg	kg	kg	kg	kg	kg	kg	kg	mm
7,5 m							4.288*	4.288*				3.298*	6.327
6 m					5.780*	5.780*	5.633*	5.457				3.062*	7.429
4,5 m			8.436*	8.436*	7.452*	7.452*	6.308*	5.263	5.109*	3.672		3.007*	8.107
3 m			10.220*	10.220*	9.126*	7.632	7.050*	4.977	5.746	3.547		3.075*	8.464
1,5 m					10.544*	7.033	7.747*	4.691	5.592	3.406		3.268*	8.543
0 m			5.879*	5.879*	11.059*	6.697	7.600	4.486	5.473	3.298		3.624*	8.351
-1,5 m	6.190*	6.190*	9.928*	9.928*	10.659*	6.592	7.496	4.393	5.429	3.257		4.266*	7.868
-3 m	10.456*	10.456*	12.710*	12.710*	9.390*	6.651	7.012*	4.422				5.482*	7.034
-4,5 m			9.004*	9.004*	6.835*	6.835*						4.926*	5.691















Hubkapazität in Längsrichtung

Hubkapazität im gesamten Schwenkbereich













Hinweise:

1. Die Hubkapazitäten basieren auf ISO 10567, d. h.: 75 % der Kipplast oder 87 % der Hydraulikhubkapazität – es gilt der jeweils kleinere Wert. Mit * markierte Hubkapazitäten basieren auf der Hydraulikkapazität.
2. Die angegebenen Hubkapazitäten setzen festen, ebenen Grund voraus.
3. Unterschiedliche Länder haben ggf. andere gesetzliche Bestimmungen. Fragen Sie bitte Ihren Händler.

NENNTRAGFÄHIGKEIT – LÖFFELSTIELLÄNGE 2,4 M, MONOAUSLEGER, BODENPLATTEN: 700HD, KEIN LÖFFEL **245XR LCD MONO**

Reichweite	1,5 m		3 m		4,5 m		6 m		7,5 m		Hubkapazität bei max. Reichweite		
													
Lastpunkthöhe	kg	kg	kg	kg	kg	kg	kg	kg	kg	kg	kg	kg	mm
7,5 m					6.828*	6.828*					5.081*	5.081*	5.585
6 m					7.081*	7.081*	6.390*	5.673			4.640*	4.578	6.811
4,5 m			11.686*	11.686*	8.237*	8.237*	6.791*	5.498	4.890*	3.857	4.530*	3.817	7.546
3 m					9.833*	7.904	7.448*	5.230	5.802	3.765	4.628*	3.452	7.929
1,5 m					10.950*	7.390	7.907	4.978	5.677	3.651	4.927*	3.321	8.013
0 m					11.041*	7.164	7.725	4.817	5.593	3.574	5.289	3.392	7.808
-1,5 m			10.237*	10.237*	10.269*	7.138	7.673	4.771			5.825	3.715	7.289
-3 m			10.987*	10.987*	8.598*	7.257	6.322*	4.864			5.634*	4.513	6.376
-4,5 m					5.121*	5.121*					4.477*	4.477*	4.850

NENNTRAGFÄHIGKEIT – LÖFFELSTIELLÄNGE 3,0 M, MONOAUSLEGER, BODENPLATTEN: 700HD, KEIN LÖFFEL **245XR LCD MONO**













Reichweite	1,5 m		3 m		4,5 m		6 m		7,5 m		Hubkapazität bei max. Reichweite		
													
Lastpunkthöhe	kg	kg	kg	kg	kg	kg	kg	kg	kg	kg	kg	kg	mm
7,5 m							4.288*	4.288*			3.298*	3.298*	6.327
6 m					5.780*	5.780*	5.633*	5.633*			3.062*	3.062*	7.429
4,5 m			8.436*	8.436*	7.452*	7.452*	6.308*	5.594	5.109*	3.922	3.007*	3.007*	8.107
3 m			10.220*	10.220*	9.126*	8.117	7.050*	5.308	5.842	3.797	3.075*	3.075*	8.464
1,5 m					10.544*	7.518	7.747*	5.022	5.688	3.657	3.268*	3.016	8.543
0 m			5.879*	5.879*	11.059*	7.182	7.732	4.816	5.570	3.548	3.624*	3.062	8.351
-1,5 m	6.190*	6.190*	9.928*	9.928*	10.659*	7.078	7.627	4.724	5.525	3.508	4.266*	3.302	7.868
-3 m	10.456*	10.456*	12.710*	12.710*	9.390*	7.136	7.012*	4.753			5.482*	3.876	7.034
-4,5 m			9.004*	9.004*	6.835*	6.835*					4.926*	4.926*	5.691















Hubkapazität in Längsrichtung
 Hubkapazität im gesamten Schwenkbereich

- Hinweise:**
1. Die Hubkapazitäten basieren auf ISO 10567, d. h.: 75 % der Kipplast oder 87 % der Hydraulikhubkapazität – es gilt der jeweils kleinere Wert. Mit * markierte Hubkapazitäten basieren auf der Hydraulikhubkapazität.
 2. Die angegebenen Hubkapazitäten setzen festen, ebenen Grund voraus.
 3. Unterschiedliche Länder haben ggf. andere gesetzliche Bestimmungen. Fragen Sie bitte Ihren Händler.













NENNTRAGFÄHIGKEIT – LÖFFELSTIELLÄNGE 2,4 M, VERSTELLAUSLEGER, BODENPLATTEN: 600HD, KEIN LÖFFEL **245XR LC VERSTELLAUSLEGER**

Reichweite	1,5 m		3 m		4,5 m		6 m		7,5 m		Hubkapazität bei max. Reichweite		
													
Lastpunkthöhe	kg	kg	kg	kg	kg	kg	kg	kg	kg	kg	kg	kg	mm
7,5 m			7.057*	7.057*	4.952*	4.952*					5.046*	5.046*	5.657
6 m			6.756*	6.756*	4.484*	4.484*	4.504*	4.504*			4.575*	4.056	6.869
4,5 m	18.167*	18.167*	8.248*	8.248*	5.134*	5.134*	4.527*	4.527*	4.448*	3.414	4.408*	3.328	7.598
3 m	8.297*	8.297*	7.990*	7.990*	4.614*	4.614*	4.708*	4.687	4.599*	3.307	4.324*	2.973	7.979
1,5 m			6.873*	6.873*	5.799*	5.799*	5.327*	4.389	4.869*	3.172	4.439*	2.839	8.063
0 m			6.422*	6.422*	8.346*	6.284	6.938*	4.198	5.137*	3.082	4.779*	2.893	7.859
-1,5 m	10.524*	10.524*	9.413*	9.413*	8.524*	6.255	6.576*	4.144			4.628*	3.179	7.343
-3 m	17.864*	17.864*	8.623*	8.623*	5.989*	5.989*	4.390*	4.251			3.629*	3.629*	6.427

NENNTRAGFÄHIGKEIT – LÖFFELSTIELLÄNGE 3,0 M, VERSTELLAUSLEGER, BODENPLATTEN: 600HD, KEIN LÖFFEL **245XR LC VERSTELLAUSLEGER**

Reichweite	1,5 m		3 m		4,5 m		6 m		7,5 m		Hubkapazität bei max. Reichweite		
													
Lastpunkthöhe	kg	kg	kg	kg	kg	kg	kg	kg	kg	kg	kg	kg	mm
7,5 m			5.329*		3.309*	5.329*	3.269*	3.309*		3.269*	3.308*	3.308*	6.405
6 m			5.020*		5.305*	5.020*	3.037*	5.305*		3.037*	3.055*	3.055*	7.495
4,5 m	7.489*		7.540*	7.489*	5.178*	7.540*	3.054*	5.178*	3.024*	3.054*	2.984*	2.984*	8.167
3 m	5.293*		8.028*	5.293*	5.293*	8.028*	3.381*	5.293*	3.194*	3.381*	3.035*	2.701	8.522
1,5 m			4.735*		5.035*	4.735*	4.058*	5.035*	3.617*	4.058*	3.206*	2.579	8.600
0 m			5.405*		7.063*	5.405*	5.356*	6.278	4.196*	4.202	3.532*	2.608	8.410
-1,5 m	7.704*	10.680*	9.480*	7.704*	9.256*	9.480*	7.020*	6.155	4.659*	4.090	4.115*	2.817	7.931
-3 m	12.788*	13.263*	8.472*	12.788*	7.141*	8.472*	5.413*	6.232		4.127	3.791*	3.330	7.104
-4,5 m	17.799*	17.799*	8.726*	8.726*	5.474*	5.474*					4.897*	4.897*	4.997

NENNTRAGFÄHIGKEIT – LÖFFELSTIELLÄNGE 2,4 M, VERSTELLAUSLEGER, BODENPLATTEN: 600HD, KEIN LÖFFEL **245XR LCD VERSTELLAUSLEGER**

Reichweite	1,5 m		3 m		4,5 m		6 m		7,5 m		Hubkapazität bei max. Reichweite		
													
Lastpunkthöhe	kg	kg	kg	kg	kg	kg	kg	kg	kg	kg	kg	kg	mm
7,5 m			7.057*	7.057*	4.952*	4.952*					5.046*	5.046*	5.657
6 m			6.756*	6.756*	4.484*	4.484*	4.504*	4.504*			4.575*	4.333	6.869
4,5 m	18.167*	18.167*	8.248*	8.248*	5.134*	5.134*	4.527*	4.527*	4.448*	3.663	4.408*	3.573	7.598
3 m	8.297*	8.297*	7.990*	7.990*	4.614*	4.614*	4.708*	4.708*	4.599*	3.556	4.324*	3.204	7.979
1,5 m			6.873*	6.873*	5.799*	5.799*	5.327*	4.717	4.869*	3.422	4.439*	3.067	8.063
0 m			6.422*	6.422*	8.346*	6.765	6.938*	4.526	5.137*	3.331	4.779*	3.128	7.859
-1,5 m	10.524*	10.524*	9.413*	9.413*	8.524*	6.736	6.576*	4.472			4.628*	3.434	7.343
-3 m	17.864*	17.864*	8.623*	8.623*	5.989*	5.989*	4.390*	4.390*			3.629*	3.629*	6.427



Hubkapazität in Längsrichtung



























Hubkapazität im gesamten Schwenkbereich

Hinweise:

1. Die Hubkapazitäten basieren auf ISO 10567, d. h.: 75 % der Kipplast oder 87 % der Hydraulikhubkapazität – es gilt der jeweils kleinere Wert. Mit * markierte Hubkapazitäten basieren auf der Hydraulikhubkapazität.
2. Die angegebenen Hubkapazitäten setzen festen, ebenen Grund voraus.
3. Unterschiedliche Länder haben ggf. andere gesetzliche Bestimmungen. Fragen Sie bitte Ihren Händler.

NENNTRAGFÄHIGKEIT – LÖFFELSTIELLÄNGE 3,0 M, VERSTELLAUSLEGER, BODENPLATTEN: 600HD, KEIN LÖFFEL												245XR LCD VERSTELLAUSLEGER	
Reichweite	1,5 m		3 m		4,5 m		6 m		7,5 m		Hubkapazität bei max. Reichweite		
													
Lastpunkthöhe	kg	kg	kg	kg	kg	kg	kg	kg	kg	kg	kg	kg	mm
7,5 m			5.329*		3.309*	5.329*	3.269*	3.309*		3.269*		3.308*	6.405
6 m			5.020*		5.020*	5.020*	3.037*	5.305*		3.037*		3.055*	7.495
4,5 m	7.489*		7.540*	7.489*	5.178*	7.540*	3.054*	5.178*	3.024*	3.054*		2.984*	8.167
3 m	5.293*		8.028*	5.293*	5.293*	8.028*	3.381*	5.293*	3.194*	3.381*		2.914	8.522
1,5 m			4.735*		5.035*	4.735*	4.058*	5.035*	3.617*	4.058*		2.791	8.600
0 m			5.405*		7.063*	5.405*	5.356*	6.759	4.196*	4.529		2.825	8.410
-1,5 m	7.704*	10.680*	9.480*	7.704*	9.256*	9.480*	7.020*	6.636	4.659*	4.418		3.050	7.931
-3 m	12.788*	13.263*	8.472*	12.788*	7.141*	8.472*	5.413*	6.712		4.455		3.596	7.104
-4,5 m	17.799*	17.799*	8.726*	8.726*	5.474*	5.474*						4.897*	4.997

NENNTRAGFÄHIGKEIT – LÖFFELSTIELLÄNGE 2,4 M, VERSTELLAUSLEGER, BODENPLATTEN: 700HD, KEIN LÖFFEL												245XR LC VERSTELLAUSLEGER	
Reichweite	1,5 m		3 m		4,5 m		6 m		7,5 m		Hubkapazität bei max. Reichweite		
													
Lastpunkthöhe	kg	kg	kg	kg	kg	kg	kg	kg	kg	kg	kg	kg	mm
7,5 m			7.057*	7.057*	4.952*	4.952*						5.046*	5.657
6 m			6.756*	6.756*	4.484*	4.484*	4.504*	4.504*				4.575*	6.869
4,5 m	18.167*	18.167*	8.248*	8.248*	5.134*	5.134*	4.527*	4.527*	4.448*	3.464		4.408*	7.598
3 m	8.297*	8.297*	7.990*	7.990*	4.614*	4.614*	4.708*	4.708*	4.599*	3.356		4.324*	7.979
1,5 m			6.873*	6.873*	5.799*	5.799*	5.327*	4.454	4.869*	3.222		4.439*	8.063
0 m			6.422*	6.422*	8.346*	6.380	6.938*	4.264	5.137*	3.132		4.779*	7.859
-1,5 m	10.524*	10.524*	9.413*	9.413*	8.524*	6.351	6.576*	4.209				4.628*	7.343
-3 m	17.864*	17.864*	8.623*	8.623*	5.989*	5.989*	4.390*	4.316				3.629*	6.427

NENNTRAGFÄHIGKEIT – LÖFFELSTIELLÄNGE 3,0 M, VERSTELLAUSLEGER, BODENPLATTEN: 700HD, KEIN LÖFFEL												245XR LC VERSTELLAUSLEGER	
Reichweite	1,5 m		3 m		4,5 m		6 m		7,5 m		Hubkapazität bei max. Reichweite		
													
Lastpunkthöhe	kg	kg	kg	kg	kg	kg	kg	kg	kg	kg	kg	kg	mm
7,5 m			5.329*	5.329*	3.309*	3.309*	3.269*	3.269*				3.308*	6.405
6 m			5.020*	5.020*	5.305*	5.305*	3.037*	3.037*				3.055*	7.495
4,5 m	7.489*		7.540*	7.540*	5.178*	5.178*	3.054*	3.054*	3.024*	3.024*		2.984*	8.167
3 m	5.293*		8.028*	8.028*	5.293*	5.293*	3.381*	3.381*	3.194*	3.194*		2.744	8.522
1,5 m			4.735*	4.735*	5.035*	5.035*	4.058*	4.058*	3.617*	3.252		3.206*	8.600
0 m			5.405*	5.405*	7.063*	6.374	5.356*	4.267	4.196*	3.121		3.532*	8.410
-1,5 m	7.704*	9.654*	9.480*	9.480*	9.256*	6.251	7.020*	4.155	4.659*	3.073		4.115*	7.931
-3 m	12.788*	13.094*	8.472*	8.472*	7.141*	6.327	5.413*	4.192				3.791*	7.104
-4,5 m	17.799*	14.044*	8.726*	8.726*	5.474*	5.474*						4.897*	4.997















Hubkapazität in Längsrichtung

Hubkapazität im gesamten Schwenkbereich













Hinweise:

1. Die Hubkapazitäten basieren auf ISO 10567, d. h.: 75 % der Kipplast oder 87 % der Hydraulikhubkapazität – es gilt der jeweils kleinere Wert. Mit * markierte Hubkapazitäten basieren auf der Hydraulikhubkapazität.
2. Die angegebenen Hubkapazitäten setzen festen, ebenen Grund voraus.
3. Unterschiedliche Länder haben ggf. andere gesetzliche Bestimmungen. Fragen Sie bitte Ihren Händler.

NENNTAGFÄHIGKEIT – LÖFFELSTIELLÄNGE 2,4 M, VERSTELLAUSLEGER, BODENPLATTEN: 700HD, KEIN LÖFFEL **245XR LCD VERSTELLAUSLEGER**

Reichweite	1,5 m		3 m		4,5 m		6 m		7,5 m		Hubkapazität bei max. Reichweite		
													
Lastpunkthöhe	kg	kg	kg	kg	kg	kg	kg	kg	kg	kg	kg	kg	mm
7,5 m			7.057*	7.057*	4.952*	4.952*					5.046*	5.046*	5.657
6 m			6.756*	6.756*	4.484*	4.484*	4.504*	4.504*			4.575*	4.390	6.869
4,5 m	18.167*	18.167*	8.248*	8.248*	5.134*	5.134*	4.527*	4.527*	4.448*	3.715	4.408*	3.623	7.598
3 m	8.297*	8.297*	7.990*	7.990*	4.614*	4.614*	4.708*	4.708*	4.599*	3.608	4.324*	3.251	7.979
1,5 m			6.873*	6.873*	5.799*	5.799*	5.327*	4.784	4.869*	3.472	4.439*	3.114	8.063
0 m			6.422*	6.422*	8.346*	6.865	6.938*	4.594	5.137*	3.382	4.779*	3.176	7.859
-1,5 m	10.524*	10.524*	9.413*	9.413*	8.524*	6.836	6.576*	4.540			4.628*	3.488	7.343
-3 m	17.864*	17.864*	8.623*	8.623*	5.989*	5.989*	4.390*	4.390*			3.629*	3.629*	6.427

NENNTAGFÄHIGKEIT – LÖFFELSTIELLÄNGE 3,0 M, VERSTELLAUSLEGER, BODENPLATTEN: 700HD, KEIN LÖFFEL **245XR LCD VERSTELLAUSLEGER**

Reichweite	1,5 m		3 m		4,5 m		6 m		7,5 m		Hubkapazität bei max. Reichweite		
													
Lastpunkthöhe	kg	kg	kg	kg	kg	kg	kg	kg	kg	kg	kg	kg	mm
7,5 m			5.329*	5.329*	3.309*	3.309*	3.269*	3.269*			3.308*	3.308*	6.405
6 m			5.020*	5.020*	5.305*	5.305*	3.037*	3.037*			3.055*	3.055*	7.495
4,5 m	7.489*		7.540*	7.540*	5.178*	5.178*	3.054*	3.054*	3.024*	3.024*	2.984*	2.984*	8.167
3 m	5.293*		8.028*	8.028*	5.293*	5.293*	3.381*	3.381*	3.194*	3.194*	3.035*	2.959	8.522
1,5 m			4.735*	4.735*	5.035*	5.035*	4.058*	4.058*	3.617*	3.503	3.206*	2.834	8.600
0 m			5.405*	5.405*	7.063*	6.859	5.356*	4.598	4.196*	3.371	3.532*	2.870	8.410
-1,5 m	7.704*	9.654*	9.480*	9.480*	9.256*	6.736	7.020*	4.486	4.659*	3.324	4.115*	3.098	7.931
-3 m	12.788*	13.094*	8.472*	8.472*	7.141*	6.812	5.413*	4.523			3.791*	3.650	7.104
-4,5 m	17.799*	14.044*	8.726*	8.726*	5.474*	5.474*					4.897*	4.897*	4.997



Hubkapazität in Längsrichtung

Hubkapazität im gesamten Schwenkbereich

Hinweise:

1. Die Hubkapazitäten basieren auf ISO 10567, d. h.: 75 % der Kipplast oder 87 % der Hydraulikhubkapazität – es gilt der jeweils kleinere Wert. Mit * markierte Hubkapazitäten basieren auf der Hydraulikhubkapazität.
2. Die angegebenen Hubkapazitäten setzen festen, ebenen Grund voraus.
3. Unterschiedliche Länder haben ggf. andere gesetzliche Bestimmungen. Fragen Sie bitte Ihren Händler.