

STATISCHE ABMESSUNGEN

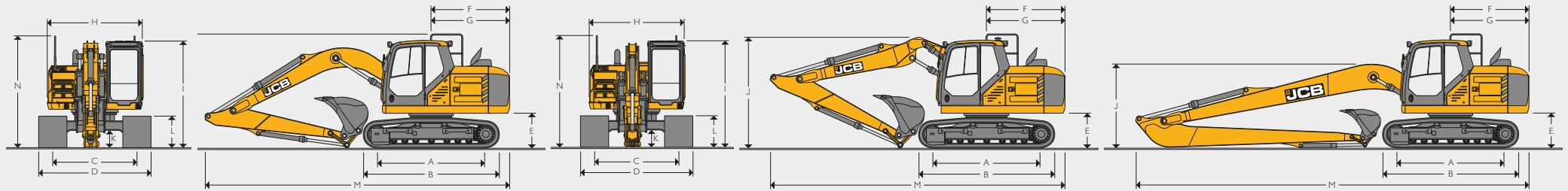

STATISCHE ABMESSUNGEN

Modell		140X LC			150X LC			150X HD									
A	Kettenaufstandsänge (mm)	2865			2865			3090									
B	Laufwerkslänge (mm)	3590			3590			3940									
C	Spurweite (mm)	1990			1990			2200									
D	Laufwerksbreite (500-mm-Bodenplatten) (mm)	2490			2490			-									
D	Laufwerksbreite (600-mm-Bodenplatten) (mm)	2590			2590			2800									
D	Laufwerksbreite (700-mm-Bodenplatten) (mm)	2690			2690			2900									
D	Laufwerksbreite (800-mm-Bodenplatten) (mm)	-			-			3000									
D	Laufwerksbreite (850-mm-Bodenplatten) (mm)	2840			2840			-									
D	Laufwerksbreite (900-mm-Bodenplatten) (mm)	-			-			3100									
E	Kontergewicht-Bodenfreiheit (mm)	905			905			1050									
F	Hecklänge (mm)	2103			2103			2103									
G	Heckschwenkradius (mm)	2150			2150			2150									
H	Oberwagenbreite (mm)	2490			2490			2490									
H	Oberwagenbreite (mit SIPS) (mm)	2619			2619			2619									
I	Höhe über Kabine (mm)	2866			2866			2916									
I	Höhe über Kabine (Vandalismusschutz – optional) (mm)	3172			3172			3319									
I	Höhe über Kabine (FOPS-Schutz) (mm)	2965			2965			3112									
J	Höhe über Handlauf (mm)	3002			3002			3149									
K	Bodenfreiheit (mm)	425			425			470									
L	Kettenhöhe (mm)	811			811			880									
		Mono			Mono			LR	T.A.B			Mono			T.A.B		
Löffelstiehlängen		2,5 m	2,7 m	3,0 m	2,5 m	2,7 m	3,0 m	5,3 m	2,5 m	2,7 m	3,0 m	2,5 m	2,7 m	3,0 m	2,5 m	2,7 m	3,0 m
M	Transportlänge (mm)	7659	7654	7604	7659	7654	7604	10390	7726	7892	7628	7659	7654	7604	7726	7892	7628
N	Transporthöhe (mm)	3002	3209	3289	3002	3209	3289	3002	3002	2908	3236	3149	3356	3543	3149	3356	3543

ARBEITSBEREICH – MONOAUSLEGER 4,7M 150X LC

Löffelstiellänge:		2,1 m	2,5 m	2,7 m	3,0 m
A Maximale Reichweite (mm)		8015	8385	8564	8841
B Maximale Reichweite (am Boden) (mm)		7863	8240	8422	8704
C Maximale Grabtiefe (mm)		5161	5564	5764	6063
D Maximale Schürfhöhe (mm)		8907	9164	9288	9503
E Maximale Überladehöhe (mm)		6411	6684	6806	7007
F Maximale vertikale Grabtiefe (mm)		4698	5098	5295	5592
G Mindestschwenradius (mm)		2156	2212	2506	2575
H Minimale Überladehöhe (mm)		2795	2393	2267	1975
I Maximale Schwenkhöhe (mm)		6436	6707	6833	7034
J Minimale Schwenkhöhe (mm)		3525	3108	2922	2630
Max. Reißkraft Löffelstiel (kgf)		7393	6587	6445	5986
Max. Ausbrechkraft Löffel (kgf)		10452	10452	10452	10452

ARBEITSBEREICH – MONOAUSLEGER 4,7M 150X HD

Löffelstiellänge:		2,5 m	3,0 m
A Maximale Reichweite (mm)		8385	8841
B Maximale Reichweite (am Boden) (mm)		8225	8689
C Maximale Grabtiefe (mm)		5484	5983
D Maximale Schürfhöhe (mm)		9240	9561
E Maximale Überladehöhe (mm)		6764	7087
F Maximale vertikale Grabtiefe (mm)		5018	5512
G Mindestschwenradius (mm)		2212	2575
H Minimale Überladehöhe (mm)		2473	2055
I Maximale Schwenkhöhe (mm)		6787	7114
J Minimale Schwenkhöhe (mm)		3188	2710
Max. Reißkraft Löffelstiel (kgf)		6587	5986
Max. Ausbrechkraft Löffel (kgf)		10452	10452

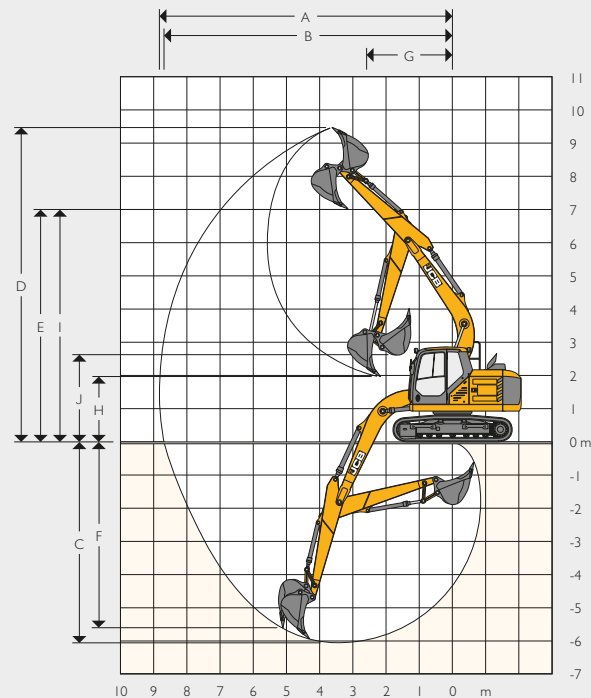



ARBEITSBEREICH – T.A.B 5,0M		ISOX LC			
Löffelstiellänge:		2,1 m	2,5 m	2,7 m	3,0 m
A	Maximale Reichweite (mm)	8410	8796	8984	9271
B	Maximale Reichweite (am Boden) (mm)	8266	8659	8849	9141
C	Maximale Grabtiefe (mm)	5417	5824	6021	6319
D	Maximale Schürfhöhe (mm)	9377	9687	9832	10064
E	Maximale Überladehöhe (mm)	6881	7192	7336	7568
F	Maximale vertikale Grabtiefe (mm)	4799	5204	5395	5691
G	Mindestschwenkradius (mm)	2616	2731	3036	3149
H	Minimale Überladehöhe (mm)	3172	2778	2696	2418
I	Maximale Schwenkhöhe (mm)	6879	7189	7334	7566
J	Minimale Schwenkhöhe (mm)	3808	3405	3262	2984
	Max. Reißkraft Löffelstiel (kgf)	7393	6587	6445	5986
	Max. Ausbrechkraft Löffel (kgf)	10452	10452	10452	10452

ARBEITSBEREICH – T.A.B 5,0M		ISOX HD	
Löffelstiellänge:		2,5 m	3,0 m
A	Maximale Reichweite (mm)	8796	9271
B	Maximale Reichweite (am Boden) (mm)	8644	9127
C	Maximale Grabtiefe (mm)	5589	6080
D	Maximale Schürfhöhe (mm)	9764	10142
E	Maximale Überladehöhe (mm)	7272	7648
F	Maximale vertikale Grabtiefe (mm)	5124	5611
G	Mindestschwenkradius (mm)	2731	3149
H	Minimale Überladehöhe (mm)	2858	2498
I	Maximale Schwenkhöhe (mm)	7269	7646
J	Minimale Schwenkhöhe (mm)	3485	3064
	Max. Reißkraft Löffelstiel (kgf)	6587	5986
	Max. Ausbrechkraft Löffel (kgf)	10452	10452

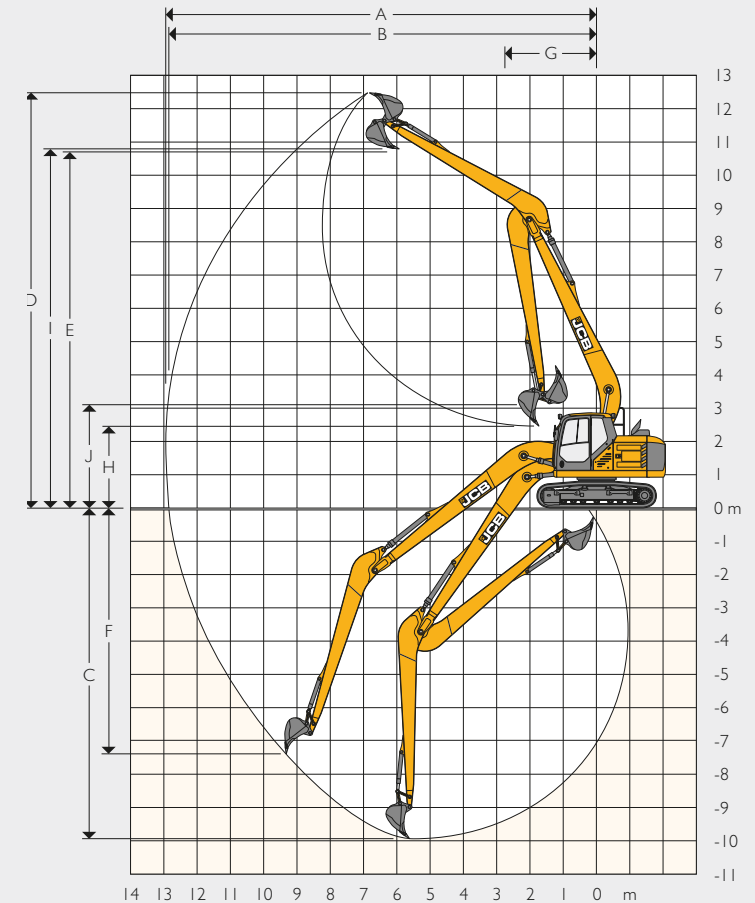
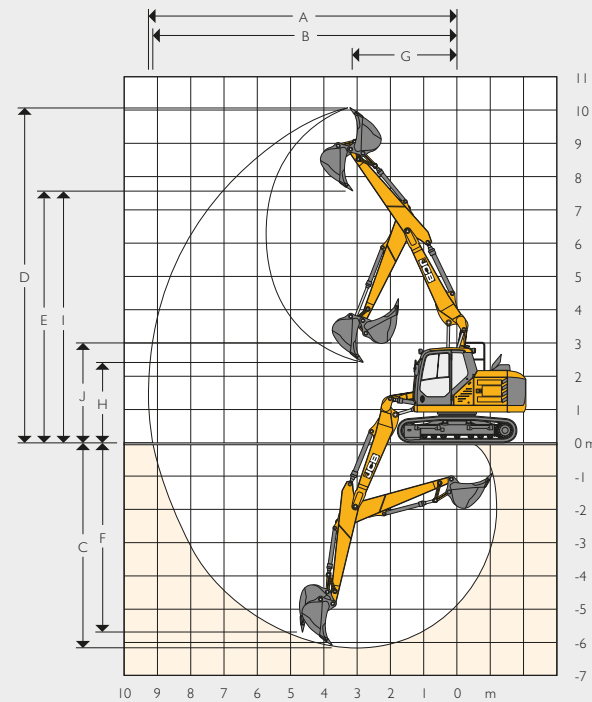









ARBEITSBEREICH – MONOAUSLEGER 7,4M		ISOX LR
Löffelstiellänge:		5,3 m
A	Maximale Reichweite (mm)	12994
B	Maximale Reichweite (am Boden) (mm)	12908
C	Maximale Grabtiefe (mm)	9992
D	Maximale Schürfhöhe (mm)	12630
E	Maximale Überladehöhe (mm)	10733
F	Maximale vertikale Grabtiefe (mm)	7426
G	Mindestschwenkradius (mm)	2769
H	Minimale Überladehöhe (mm)	2455
I	Maximale Schwenkhöhe (mm)	10832
J	Minimale Schwenkhöhe (mm)	3110
	Max. Reißkraft Löffelstiel (kgf)	3824
	Max. Ausbrechkraft Löffel (kgf)	7036













HUBKAPAZITÄTEN – LÖFFELSTIELLÄNGE: 2,1 M, MONOAUSLEGER: 4,7 M, BODENPLATTEN: 500 MM, OHNE LÖFFEL **150X LC MONO**

Reichweite	3 m		4 m		5 m		6 m		Kapazität bei max. Reichweite		
											
Lastpunkthöhe	kg	kg	kg	kg	kg	kg	kg	kg	kg	kg	(mm)
6 m			3210*	3210*	2950*	2950*			2940*	2940*	5001
4,5 m	3880*	3880*	3550*	3550*	3370*	3370*		2890*	2690*	2690*	6027
3 m	5990*	5990*	4540*	4540*	3870*	3750*		3520*	2660*	2500*	6562
1,5 m			5650*	4890	4490*	3590		3850*	2790*	2360	6726
0 m	6390*	6390*	6220*	4710	4890*	3470		3960	2720	3120*	6547
- 1,5 m	8040*	7240	6140*	4680	4870*	3440				3820*	5994
- 3 m	6790*	6790*	5260*	4760						3960*	4941

HUBKAPAZITÄTEN – LÖFFELSTIELLÄNGE: 2,5 M, MONOAUSLEGER: 4,7 M, BODENPLATTEN: 500 MM, OHNE LÖFFEL **150X LC MONO**

Reichweite	3 m		4 m		5 m		6 m		Kapazität bei max. Reichweite		
											
Lastpunkthöhe	kg	kg	kg	kg	kg	kg	kg	kg	kg	kg	(mm)
6 m			2780*	2780*	2970*	2970*			2350*	2350*	5491
4,5 m			3160*	3160*	3070*	3070*		2960	2180*	2180*	6438
3 m	5280*	5280*	4160*	4160*	3610*	3610*		3310*	2890	2160*	6942
1,5 m	7570*	7520	5350*	4930	4280*	3600		3690*	2790	2270*	7096
0 m	7090*	7090*	6100*	4720	4790*	3470		3950	2700	2520*	6927
- 1,5 m	8250*	7180	6200*	4650	4900*	3410		3920	2670	3030*	6407
- 3 m	7270*	7270*	5580*	4690	4330*	3450				3780*	5436

HUBKAPAZITÄTEN – LÖFFELSTIELLÄNGE: 2,7 M, MONOAUSLEGER: 4,7 M, BODENPLATTEN: 500 MM, OHNE LÖFFEL **150X LC MONO**

Reichweite	3 m		4 m		5 m		6 m		Kapazität bei max. Reichweite		
											
Lastpunkthöhe	kg	kg	kg	kg	kg	kg	kg	kg	kg	kg	(mm)
6 m			2570*	2570*	2780*	2780*			2470*	2470*	5720
4,5 m			2960*	2960*	2920*	2920*		2920*	2300*	2300*	6635
3 m	4910*	4910*	3950*	3950*	3470*	3470*		3190*	2890	2290*	7124
1,5 m	7250*	7250*	5170*	4940	4160*	3600		3600*	2780	2410*	7275
0 m	7290*	7190	5990*	4700	4700*	3450		3930*	2690	2660*	7110
- 1,5 m	8290*	7120	6180*	4610	4880*	3380		3890	2650	3170*	6605
- 3 m	7430*	7210	5680*	4640	4450*	3410				3680*	5668











Hubkapazität in Längsrichtung.

Hubkapazität im gesamten Schwenkbereich.











Anmerkungen:

1. Hubkapazitäten basieren auf ISO 10567, d. h. 75 % der Kippplast oder 87 % der Hydraulikhubkapazität – es gilt der kleinere Wert. Mit * markierte Hubkapazitäten basieren auf der Hydraulikhubkapazität.
2. Die angegebenen Hubkapazitäten setzen festen, ebenen Grund voraus.
3. Möglicherweise unterliegen die Hubkapazitäten landesabhängigen Bestimmungen. Fragen Sie bitte Ihren Händler.











HUBKAPAZITÄTEN – LÖFFELSTIELLÄNGE: 3,0 M, MONOAUSLEGER: 4,7 M, BODENPLATTEN: 500 MM, OHNE LÖFFEL **150X LC MONO**

Reichweite	3 m		4 m		5 m		6 m		Kapazität bei max. Reichweite		
											
Lastpunkthöhe	kg	kg	kg	kg	kg	kg	kg	kg	kg	kg	(mm)
6 m					2520*	2520*	2390*	2390*	2160*	2160*	6072
4,5 m			2660*	2660*	2690*	2690*	2720*	2720*	2030*	2030*	6940
3 m	4380*	4380*	3650*	3650*	3260*	3260*	3030*	2910	2020*	2020*	7409
1,5 m	6800*	6800*	4910*	4910*	3990*	3620	3460*	2790	2120*	1980	7554
0 m	7810*	7200	5840*	4710	4590*	3450	3840*	2680	2330*	2000	7395
- 1,5 m	8330*	7080	6160*	4590	4850*	3360	3870	2630	2750*	2180	6911
- 3 m	7670*	7130	5820*	4600	4580*	3370	3550*	2660	3530*	2650	6023

HUBKAPAZITÄTEN – LÖFFELSTIELLÄNGE: 2,1 M, MONOAUSLEGER: 4,7 M, BODENPLATTEN: 500 MM, OHNE LÖFFEL **150X LCD MONO**

Reichweite	3 m		4 m		5 m		6 m		Kapazität bei max. Reichweite		
											
Lastpunkthöhe	kg	kg	kg	kg	kg	kg	kg	kg	kg	kg	(mm)
6 m			3210*	3210*	2950*	2950*			2940*	2940*	5001
4,5 m	3880*	3880*	3550*	3550*	3370*	3370*	2890*	2890*	2690*	2690*	6027
3 m	5990*	5990*	4540*	4540*	3870*	3870*	3520*	3000	2660*	2610	6562
1,5 m			5650*	5100	4490*	3740	3850*	2910	2790*	2470	6726
0 m	6390*	6390*	6220*	4920	4890*	3630	4070*	2840	3120*	2530	6547
- 1,5 m	8040*	7560	6140*	4890	4870*	3590			3820*	2840	5994
- 3 m	6790*	6790*	5260*	4970					3960*	3740	4941

HUBKAPAZITÄTEN – LÖFFELSTIELLÄNGE: 2,5 M, MONOAUSLEGER: 4,7 M, BODENPLATTEN: 500 MM, OHNE LÖFFEL **150X LCD MONO**

Reichweite	3 m		4 m		5 m		6 m		Kapazität bei max. Reichweite		
											
Lastpunkthöhe	kg	kg	kg	kg	kg	kg	kg	kg	kg	kg	(mm)
6 m			2780*	2780*	2970*	2970*			2350*	2350*	5491
4,5 m			3160*	3160*	3070*	3070*	3070*	3070*	2180*	2180*	6438
3 m	5280*	5280*	4160*	4160*	3610*	3610*	3310*	3010	2160*	2160*	6942
1,5 m	7570*	7570*	5350*	5140	4280*	3760	3690*	2910	2270*	2270*	7096
0 m	7090*	7090*	6100*	4930	4790*	3620	3990*	2830	2520*	2330	6927
- 1,5 m	8250*	7500	6200*	4860	4900*	3560	3980*	2800	3030*	2570	6407
- 3 m	7270*	7270*	5580*	4900	4330*	3610			3780*	3240	5436



Hubkapazität in Längsrichtung.

Hubkapazität im gesamten Schwenkbereich.









Anmerkungen:

1. Hubkapazitäten basieren auf ISO 10567, d. h. 75 % der Kipplast oder 87 % der Hydraulikhubkapazität – es gilt der kleinere Wert. Mit * markierte Hubkapazitäten basieren auf der Hydraulikhubkapazität.
2. Die angegebenen Hubkapazitäten setzen festen, ebenen Grund voraus.
3. Möglicherweise unterliegen die Hubkapazitäten landesabhängigen Bestimmungen. Fragen Sie bitte Ihren Händler.



HUBKAPAZITÄTEN – LÖFFELSTIELLÄNGE: 2,7 M, MONOAUSLEGER: 4,7 M, BODENPLATTEN: 500 MM, OHNE LÖFFEL **ISOX LCD MONO**

Reichweite	3 m		4 m		5 m		6 m		Kapazität bei max. Reichweite		
											(mm)
Lastpunkthöhe	kg	kg	kg	kg	kg	kg	kg	kg	kg	kg	(mm)
6 m			2570*	2570*	2780*	2780*			2470*	2470*	5721
4,5 m			2960*	2960*	2920*	2920*	2920*	2920*	2300*	2300*	6635
3 m	4910*	4910*	3950*	3950*	3470*	3470*	3190*	3020	2290*	2290*	7124
1,5 m	7250*	7250*	5170*	5150	4160	3760	3600*	2910	2410*	2200	7275
0 m	7290*	7290*	5990*	4910	4700*	3610	3930*	2810	2660*	2230	7110
- 1,5 m	8290*	7440	6180*	4820	4880*	3540	3990*	2770	3170*	2450	6605
- 3 m	7430*	7430*	5680*	4850	4450*	3560			3680*	3040	5668

HUBKAPAZITÄTEN – LÖFFELSTIELLÄNGE: 3,0 M, MONOAUSLEGER: 4,7 M, BODENPLATTEN: 500 MM, OHNE LÖFFEL **ISOX LCD MONO**

Reichweite	3 m		4 m		5 m		6 m		Kapazität bei max. Reichweite		
											(mm)
Lastpunkthöhe	kg	kg	kg	kg	kg	kg	kg	kg	kg	kg	(mm)
6 m					2520*	2520*	2390*	2390*	2160*	2160*	6072
4,5 m			2660*	2660*	2690*	2690*	2720*	2720*	2030*	2030*	6940
3 m	4380*	4380*	3650*	3650*	3260*	3260*	3030*	3030	2020*	2020*	7409
1,5 m	6800*	6800*	4910*	4910*	3990*	3780	3460*	2910	2120*	2070	7554
0 m	7810*	7520	5840*	4920	4590*	3610	3840*	2810	2330*	2100	7395
- 1,5 m	8330*	7400	6160*	4800	4850*	3520	3980*	2750	2750*	2290	6911
- 3 m	7670*	7450	5820*	4810	4580*	3520	3550*	2780	3530*	2770	6023

HUBKAPAZITÄTEN – LÖFFELSTIELLÄNGE: 2,1 M, MONOAUSLEGER: 4,7 M, BODENPLATTEN: 500 MM, OHNE LÖFFEL **ISOX HD MONO**

Reichweite	3 m		4 m		5 m		6 m		Kapazität bei max. Reichweite		
											(mm)
Lastpunkthöhe	kg	kg	kg	kg	kg	kg	kg	kg	kg	kg	(mm)
6 m			3210*	3210*	2950*	2950*			2940*	2940*	5001
4,5 m	3880*	3880*	3550*	3550*	3370*	3370*	2890*	2890*	2690*	2690*	6027
3 m	5990*	5990*	4540*	4540*	3870*	3870*	3520*	3500	2660*	2660*	6562
1,5 m			5650*	5650*	4490*	4410	3850*	3410	2790*	2790*	6726
0 m	6390*	6390*	6220*	5870	4890*	4290	4070*	3340	3120*	2980	6547
- 1,5 m	8040*	8040*	6140*	5840	4870*	4250			3820*	3350	5994
- 3 m	6790*	6790*	5260*	5260*					3960*	3960*	4941



Hubkapazität in Längsrichtung.











Anmerkungen:

1. Hubkapazitäten basieren auf ISO 10567, d. h. 75 % der Kipplast oder 87 % der Hydraulikhubkapazität – es gilt der kleinere Wert. Mit * markierte Hubkapazitäten basieren auf der Hydraulikhubkapazität.
2. Die angegebenen Hubkapazitäten setzen festen, ebenen Grund voraus.
3. Möglicherweise unterliegen die Hubkapazitäten landesabhängigen Bestimmungen. Fragen Sie bitte Ihren Händler.













Hubkapazität im gesamten Schwenkbereich.











HUBKAPAZITÄTEN – LÖFFELSTIELLÄNGE: 2,5 M, MONOAUSLEGER: 4,7 M, BODENPLATTEN: 500 MM, OHNE LÖFFEL **ISOX HD MONO**

Reichweite	3 m		4 m		5 m		6 m		Kapazität bei max. Reichweite		
											(mm)
Lastpunkthöhe	kg	kg	kg	kg	kg	kg	kg	kg	kg	kg	(mm)
6 m			2780*	2780*	2970*	2970*			2350*	2350*	5491
4,5 m			3160*	3160*	3070*	3070*			2180*	2180*	6438
3 m	5280*	5280*	4160*	4160*	3610	3610*	3070*	3070*	2160*	2160*	6942
1,5 m	7570*	7570*	5350*	5350*	4280*	4280*	3690*	3420	2270*	2270*	7096
0 m	7090*	7090*	6100*	5880	4790*	4280	3990*	3330	2520*	2520*	6927
- 1,5 m	8250*	8250*	6200*	5800	4900*	4220	3980*	3300	3030*	3030	6407
- 3 m	7270*	7270*	5580*	5580*	4330*	4270			3780*	3780*	5436

HUBKAPAZITÄTEN – LÖFFELSTIELLÄNGE: 2,7 M, MONOAUSLEGER: 4,7 M, BODENPLATTEN: 500 MM, OHNE LÖFFEL **ISOX HD MONO**

Reichweite	3 m		4 m		5 m		6 m		Kapazität bei max. Reichweite		
											(mm)
Lastpunkthöhe	kg	kg	kg	kg	kg	kg	kg	kg	kg	kg	(mm)
6 m			2570*	2570*	2780*	2780*			2470*	2470*	5721
4,5 m			2960*	2960*	2920*	2920*	2920*	2920*	2300*	2300*	6635
3 m	4910*	4910*	3950*	3950*	3470*	3470*	3190*	3190*	2290*	2290*	7124
1,5 m	7250*	7250*	5170*	5170*	4160*	4160*	3600*	3410	2410*	2410*	7275
0 m	7290*	7290*	5990*	5860	4700*	4270	3930*	3320	2660*	2630	7110
- 1,5 m	8290*	8290*	6180*	5770	4880*	4200	3990*	3280	3170*	2890	6605
- 3 m	7430*	7430*	5680*	5680*	4450*	4220			3680*	3580	5668

HUBKAPAZITÄTEN – LÖFFELSTIELLÄNGE: 3,0 M, MONOAUSLEGER: 4,7 M, BODENPLATTEN: 500 MM, OHNE LÖFFEL **ISOX HD MONO**

Reichweite	3 m		4 m		5 m		6 m		Kapazität bei max. Reichweite		
											(mm)
Lastpunkthöhe	kg	kg	kg	kg	kg	kg	kg	kg	kg	kg	(mm)
6 m					2520*	2520*	2390*	2390*	2160*	2160*	6072
4,5 m			2660*	2660*	2690*	2690*	2720*	2720*	2030*	2030*	6940
3 m	4380*	4380*	3650*	3650*	3260*	3260*	3030*	3030*	2020*	2020*	7409
1,5 m	6800*	6800*	4910*	4910*	3990*	3990*	3460*	3420	2120*	2120*	7554
0 m	7810*	7810*	5840*	5840*	4590*	4270	3840*	3310	2330*	2330*	7395
- 1,5 m	8330*	8330*	6160*	5740	4850*	4180	3980*	3260	2750*	2700	6911
- 3 m	7670*	7670*	5820*	5760	4580*	4180	3550*	3290	3530*	3270	6023



Hubkapazität in Längsrichtung.













Hubkapazität im gesamten Schwenkbereich.











Anmerkungen:

1. Hubkapazitäten basieren auf ISO 10567, d. h. 75 % der Kipplast oder 87 % der Hydraulikhubkapazität – es gilt der kleinere Wert. Mit * markierte Hubkapazitäten basieren auf der Hydraulikhubkapazität.
2. Die angegebenen Hubkapazitäten setzen festen, ebenen Grund voraus.
3. Möglicherweise unterliegen die Hubkapazitäten landesabhängigen Bestimmungen. Fragen Sie bitte Ihren Händler.











HUBKAPAZITÄTEN – LÖFFELSTIELLÄNGE: 2,1 M, T.A.B.: 5,0 M, BODENPLATTEN: 500 MM, OHNE LÖFFEL I50X LC T.A.B.

Reichweite	3 m		4 m		5 m		6 m		Kapazität bei max. Reichweite		
											
Lastpunkthöhe	kg	kg	kg	kg	kg	kg	kg	kg	kg	kg	(mm)
6 m			3170*	3170*	3160*	3160*			3140*	3140*	5505
4,5 m	4190*	4190*	3610*	3610*	3290*	3290*	3140*	2900	2840*	2550	6450
3 m			4580*	4580*	3790*	3680	3370*	2810	2760*	2230	6952
1,5 m			5570*	4710	4360*	3470	3680*	2700	2820*	2110	7107
0 m			6000*	4530	4710*	3340	3880	2610	3040*	2150	6938
- 1,5 m	7540	7000	5860	4500	4670	3300	3790*	2600	3390*	2400	6419
- 3 m			5060*	4590	3950*	3380			3600*	3150	5290

HUBKAPAZITÄTEN – LÖFFELSTIELLÄNGE: 2,5 M, T.A.B.: 5,0 M, BODENPLATTEN: 500 MM, OHNE LÖFFEL I50X LC T.A.B.

Reichweite	3 m		4 m		5 m		6 m		Kapazität bei max. Reichweite		
											
Lastpunkthöhe	kg	kg	kg	kg	kg	kg	kg	kg	kg	kg	(mm)
6 m			2810*	2810*	2840*	2840*			2510*	2510*	5994
4,5 m			3270*	3270*	3040*	3040*	2910*	2910*	2300*	2300*	6871
3 m			4240*	4240*	3570*	3570*	3190*	2830	2240*	2050	7345
1,5 m			5310*	4770	4180*	3490	3550*	2700	2300*	1950	7491
0 m			5900*	4350	4610*	3330	3820*	2600	2470*	1980	7331
- 1,5 m	7410*	6920	5920*	4470	4690*	3270	3830*	2560	2830*	2170	6842
- 3 m	6850*	6850*	5340*	4530	4230*	3310			3190*	2670	5943

HUBKAPAZITÄTEN – LÖFFELSTIELLÄNGE: 2,7 M, T.A.B.: 5,0 M, BODENPLATTEN: 500 MM, OHNE LÖFFEL I50X LC T.A.B.

Reichweite	3 m		4 m		5 m		6 m		Kapazität bei max. Reichweite		
											
Lastpunkthöhe	kg	kg	kg	kg	kg	kg	kg	kg	kg	kg	(mm)
6 m					2690*	2690*	2800*	2800*	2610*	2610*	6228
4,5 m			3090*	3090*	2900*	2900*	2790*	2790*	2410*	2220	7076
3 m			4050*	4050*	3440*	3440*	3080*	2840	2360*	1960	7536
1,5 m			5140*	4780	4070*	3500	3460*	2700	2420*	1870	7679
0 m			5810*	4510	4540*	3320	3760*	2590	2590*	1890	7523
- 1,5 m	7140*	6850	5910*	4430	4670*	3240	3800	2540	2950*	2070	7048
- 3 m	7010*	6970	5420*	4470	4300*	3270	3340*	2590	3110*	2510	6179





Hubkapazität in Längsrichtung.

Hubkapazität im gesamten Schwenkbereich.









Anmerkungen:

1. Hubkapazitäten basieren auf ISO 10567, d. h. 75 % der Kipplast oder 87 % der Hydraulikhubkapazität – es gilt der kleinere Wert. Mit * markierte Hubkapazitäten basieren auf der Hydraulikhubkapazität.
2. Die angegebenen Hubkapazitäten setzen festen, ebenen Grund voraus.
3. Möglicherweise unterliegen die Hubkapazitäten landesabhängigen Bestimmungen. Fragen Sie bitte Ihren Händler.











HUBKAPAZITÄTEN – LÖFFELSTIELLÄNGE: 3,0 M, T.A.B.: 5,0 M, BODENPLATTEN: 500 MM, OHNE LÖFFEL **ISOX LC T.A.B.**

Reichweite	3 m		4 m		5 m		6 m		Kapazität bei max. Reichweite		
											
Lastpunkthöhe	kg	kg	kg	kg	kg	kg	kg	kg	kg	kg	(mm)
6 m					2470*	2470*	2570*	2570*	2280*	2280*	6580
4,5 m			2830	2830	2710*	2710*	2630*	2630*	2120	2070	7388
3 m			3780	3780	3250*	3250*	2940*	2940*	2070*	1850	7830
1,5 m			4910	4830	3910*	3520	3340*	2710	2130*	1760	7967
0 m			5680	4520	4440*	3320	3680*	2580	2280*	1780	7817
- 1,5 m	6900	6800	5900	4400	4640*	3220	3780	2520	2570*	1930	7361
- 3 m	7240	6880	5550	4420	4400*	3230	3520*	2540	2990*	2290	6535

HUBKAPAZITÄTEN – LÖFFELSTIELLÄNGE: 2,1 M, T.A.B.: 4,7 M, BODENPLATTEN: 500 MM, OHNE LÖFFEL **ISOX LCD T.A.B.**

Reichweite	3 m		4 m		5 m		6 m		Kapazität bei max. Reichweite		
											
Lastpunkthöhe	kg	kg	kg	kg	kg	kg	kg	kg	kg	kg	(mm)
6 m			3170*	3170*	3160*	3160*			3140*	3140*	5505
4,5 m	4190*	4190*	3610*	3610*	3290*	3290*	3140*	3020	2840*	2670	6450
3 m			4580*	4580*	3790*	3790*	3370*	2940	2760*	2330	6952
1,5 m			5570*	4920	4360*	3630	3680*	2820	2820*	2210	7107
0 m			6000*	4740	4710*	3490	3890*	2740	3040*	2260	6938
- 1,5 m	7540	7320	5860*	4710	4670*	3460	3790*	2720	3390*	2510	6419
- 3 m			5060*	4800	3950*	3540			3600*	3300	5290

HUBKAPAZITÄTEN – LÖFFELSTIELLÄNGE: 2,5 M, T.A.B.: 4,7 M, BODENPLATTEN: 500 MM, OHNE LÖFFEL **ISOX LCD T.A.B.**

Reichweite	3 m		4 m		5 m		6 m		Kapazität bei max. Reichweite		
											
Lastpunkthöhe	kg	kg	kg	kg	kg	kg	kg	kg	kg	kg	(mm)
6 m			2810*	2810*	2840*	2840*			2510*	2510*	5994
4,5 m			3270*	3270*	3040*	3040*	2910*	2910*	2300*	2300*	6871
3 m			4240*	4240*	3570*	3570*	3190*	2960	2240*	2150	7345
1,5 m			5310*	4980	4180*	3650	3550*	2830	2300*	2040	7491
0 m			5900*	4740	4610*	3490	3820*	2730	2470*	2080	7331
- 1,5 m	7410*	7240	5920*	4680	4690*	3430	3840*	2690	2830*	2280	6842
- 3 m	6850*	6850*	5340*	4740	4230*	3470			3190*	2800	5943













Hubkapazität in Längsrichtung.

Hubkapazität im gesamten Schwenkbereich.











Anmerkungen:

1. Hubkapazitäten basieren auf ISO 10567, d. h. 75 % der Kipplast oder 87 % der Hydraulikhubkapazität – es gilt der kleinere Wert. Mit * markierte Hubkapazitäten basieren auf der Hydraulikhubkapazität.
2. Die angegebenen Hubkapazitäten setzen festen, ebenen Grund voraus.
3. Möglicherweise unterliegen die Hubkapazitäten landesabhängigen Bestimmungen. Fragen Sie bitte Ihren Händler.











HUBKAPAZITÄTEN – LÖFFELSTIELLÄNGE: 2,7 M, T.A.B.: 4,7 M, BODENPLATTEN: 500 MM, OHNE LÖFFEL **ISOX LCD T.A.B.**

Reichweite	3 m		4 m		5 m		6 m		Kapazität bei max. Reichweite		
											
Lastpunkthöhe	kg	kg	kg	kg	kg	kg	kg	kg	kg	kg	(mm)
6 m					2690*	2690*	2800*	2800*	2610*	2610*	6228
4,5 m			3090*	3090*	2900*	2900*	2790*	2790*	2410*	2320	7076
3 m			4050*	4050*	3440*	3440*	3080*	2960	2360*	2060	7536
1,5 m			5140*	4990	4070*	3650	3460*	2830	2420*	1960	7679
0 m			5810*	4720	4540*	3480	3760*	2710	2590*	1990	7523
- 1,5 m	7140*	7140*	5910*	4640	4670*	3400	3830*	2660	2950*	2170	7048
- 3 m	7010*	7010*	5420*	4680	4300*	3430	3340*	2710	3110*	2630	6179

HUBKAPAZITÄTEN – LÖFFELSTIELLÄNGE: 3,0 M, T.A.B.: 4,7 M, BODENPLATTEN: 500 MM, OHNE LÖFFEL **ISOX LCD T.A.B.**

Reichweite	3 m		4 m		5 m		6 m		Kapazität bei max. Reichweite		
											
Lastpunkthöhe	kg	kg	kg	kg	kg	kg	kg	kg	kg	kg	(mm)
6 m					2470*	2470*	2570*	2570*	2280*	2280*	6580
4,5 m			2830*	2830*	2710*	2710*	2630*	2630*	2120*	2120*	7388
3 m			3780*	3780*	3250*	3250*	2940*	2940*	2070*	1940	7830
1,5 m			4910*	4910*	3910*	3680	3340*	2840	2130*	1850	7967
0 m			5680*	4730	4440*	3480	3680*	2710	2280*	1870	7817
- 1,5 m	6900*	6900*	5900*	4610	4640*	3380	3810*	2640	2570*	2030	7361
- 3 m	7240*	7200	5550*	4630	4400*	3390	3520*	2660	2990*	2410	6535

HUBKAPAZITÄTEN – LÖFFELSTIELLÄNGE: 2,1 M, MONOAUSLEGER: 4,7 M, BODENPLATTEN: 500 MM, OHNE LÖFFEL **ISOX HD T.A.B.**

Reichweite	3 m		4 m		5 m		6 m		Kapazität bei max. Reichweite		
											
Lastpunkthöhe	kg	kg	kg	kg	kg	kg	kg	kg	kg	kg	(mm)
6 m			3480	3480	2950	2950			2940	2940	5001
4,5 m	4230*	4230*	3820*	3820*	3590*	3590*	2890*	2890*	2690*	2690*	6027
3 m	6350*	6350*	4810*	4810*	4080*	4080*	3690*	3690*	2660*	2660*	6562
1,5 m			5880*	5700	4670*	4190	3990*	3250	2790*	2750	6726
0 m	6390*	6390*	6390*	5450	5030*	4020	4170*	3140	3120*	2790	6547
- 1,5 m	8120	8120*	6230*	5330	4940*	3920			3820*	3080	5994
- 3 m	6780*	6780*	5270*	5270*					3950*	3950*	4941













Hubkapazität in Längsrichtung.

Hubkapazität im gesamten Schwenkbereich.











Anmerkungen:

1. Hubkapazitäten basieren auf ISO 10567, d. h. 75 % der Kipplast oder 87 % der Hydraulikhubkapazität – es gilt der kleinere Wert. Mit * markierte Hubkapazitäten basieren auf der Hydraulikkapazität.
2. Die angegebenen Hubkapazitäten setzen festen, ebenen Grund voraus.
3. Möglicherweise unterliegen die Hubkapazitäten landesabhängigen Bestimmungen. Fragen Sie bitte Ihren Händler.











HUBKAPAZITÄTEN – LÖFFELSTIELLÄNGE: 2,5 M, T.A.B.: 4,7 M, BODENPLATTEN: 500 MM, OHNE LÖFFEL **150X HD T.A.B.**

Reichweite	3 m		4 m		5 m		6 m		Kapazität bei max. Reichweite		
											
Lastpunkthöhe	kg	kg	kg	kg	kg	kg	kg	kg	kg	kg	(mm)
6 m			3060*	3060*	3210*	3210*			2390*	2390*	5508
4,5 m			3440*	3440*	3300*	3300*			2210*	2210*	6453
3 m	5640*	5640*	4440*	4440*	3830*	3830*	3250*	3250*	2190*	2190*	6955
1,5 m	7870*	7870*	5590*	5590*	4480*	4220	3850*	3270	2280*	2280*	7110
0 m	6980*	6980*	6280*	5470	4940*	4030	4110*	3150	2520*	2520*	6941
- 1,5 m	8350*	8130	6310*	5310	4990*	3920	4060*	3070	3020*	2810	6422
- 3 m	7270*	7270*	5610*	5270	4360*	3880			3770*	3470	5453

HUBKAPAZITÄTEN – LÖFFELSTIELLÄNGE: 2,7 M, T.A.B.: 4,7 M, BODENPLATTEN: 500 MM, OHNE LÖFFEL **150X HD T.A.B.**

Reichweite	3 m		4 m		5 m		6 m		Kapazität bei max. Reichweite		
											
Lastpunkthöhe	kg	kg	kg	kg	kg	kg	kg	kg	kg	kg	(mm)
6 m			2830*	2830*	3000*	3000*			2470*	2470*	5721
4,5 m			3220*	3220*	3140*	3140*	3100*	3100*	2300*	2300*	6635
3 m	5270*	5270*	4230*	4230*	3680*	3680*	3360*	3360*	2290*	2290*	7124
1,5 m	7580*	7580*	5420*	5420*	4360*	4220	3750*	3260	2410*	2410*	7275
0 m	7290*	7290*	6190*	5470	4860*	4020	4050*	3140	2660*	2470	7110
- 1,5 m	8420*	8120	6310*	5300	4980*	3900	4060*	3050	3170*	2680	6605
- 3 m	7470*	7470*	5720*	5240	4480*	3850			3690*	3260	5668

HUBKAPAZITÄTEN – LÖFFELSTIELLÄNGE: 3,0 M, T.A.B.: 4,7 M, BODENPLATTEN: 500 MM, OHNE LÖFFEL **150X HD T.A.B.**

Reichweite	3 m		4 m		5 m		6 m		Kapazität bei max. Reichweite		
											
Lastpunkthöhe	kg	kg	kg	kg	kg	kg	kg	kg	kg	kg	(mm)
6 m					2740*	2740*	2440*	2440*	2180*	2180*	6081
4,5 m			2930*	2930*	2920*	2920*	2910*	2910*	2040*	2040*	6948
3 m	4740*	4740*	3930*	3930*	3480*	3480*	3210*	3210*	2040*	2040*	7416
1,5 m	7140*	7140*	5170*	5170*	4190*	4190*	3630*	3630	2130*	2130*	7561
0 m	7760*	7760*	6050*	5490	4760*	4040	3970*	3150	2330*	2330	7403
- 1,5 m	8480*	8100	6300*	5290	4970*	3890	4070*	3040	2750*	2510	6919
- 3 m	7720*	7720*	5880*	5210	4630*	3830	3580*	3010	3540*	2990	6032



Hubkapazität in Längsrichtung.











Hubkapazität im gesamten Schwenkbereich.

Anmerkungen:

1. Hubkapazitäten basieren auf ISO 10567, d. h. 75 % der Kipplast oder 87 % der Hydraulikhubkapazität – es gilt der kleinere Wert. Mit * markierte Hubkapazitäten basieren auf der Hydraulikhubkapazität.
2. Die angegebenen Hubkapazitäten setzen festen, ebenen Grund voraus.
3. Möglicherweise unterliegen die Hubkapazitäten landesabhängigen Bestimmungen. Fragen Sie bitte Ihren Händler.

HUBKAPAZITÄTEN – LÖFFELSTIELLÄNGE: 5,3 M, MONOAUSLEGER: 7,4 M, BODENPLATTEN: 500 MM, OHNE LÖFFEL **I50X LC LR**

Reichweite	3 m		6 m		9 m		12 m		Kapazität bei max. Reichweite		
	 kg	 kg	 kg	 kg	 kg	 kg	 kg	 kg	 kg	 kg	(mm)
9 m					1070*	1070*			780*	780*	9384
7,5 m					1210*	1210*			750*	750*	10410
6 m					1270*	1270*			740*	740*	11142
4,5 m			1590*	1590*	1390*	1390*			750*	750*	11635
3 m	3880*	3880*	2020*	2020*	1550*	1550*			780*	780*	11919
1,5 m	3110*	3110*	2500*	2500*	1730*	1520	840*	840*	830*	830*	12010
0 m	2470*	2470*	2910*	2520	1890*	1430			900*	900*	11911
- 1,5 m	2930*	2930*	3190*	2360	1890*	1430			1010*	920	11618
- 3 m	3680*	3680*	3340*	2280	2040	1360			1180*	980	11115
- 4,5 m	4600*	4600*	3340*	2260	2020	1300			1450*	1080	10372
- 6 m	5720*	5720*	3180*	2290	1970*	1330			1870*	1270	9331
- 7,5 m	5220*	5220*	2800*	2380					1990*	1670	7873
- 9 m									2110*	2110*	5682



Hubkapazität in Längsrichtung.

Hubkapazität im gesamten Schwenkbereich.

Anmerkungen:

1. Hubkapazitäten basieren auf ISO 10567, d. h. 75 % der Kipplast oder 87 % der Hydraulikhubkapazität – es gilt der kleinere Wert. Mit * markierte Hubkapazitäten basieren auf der Hydraulikhubkapazität.
2. Die angegebenen Hubkapazitäten setzen festen, ebenen Grund voraus.
3. Möglicherweise unterliegen die Hubkapazitäten landesabhängigen Bestimmungen. Fragen Sie bitte Ihren Händler.